

DECORACIÓN

MATERIA PRIMA

ACCESORIO SANITARIO

BRIDAS, SOLDAR, ROSCAR

BOMBAS E INTERCAMBIADORES

CONEXIONES RÁPIDAS Y MANGUERAS

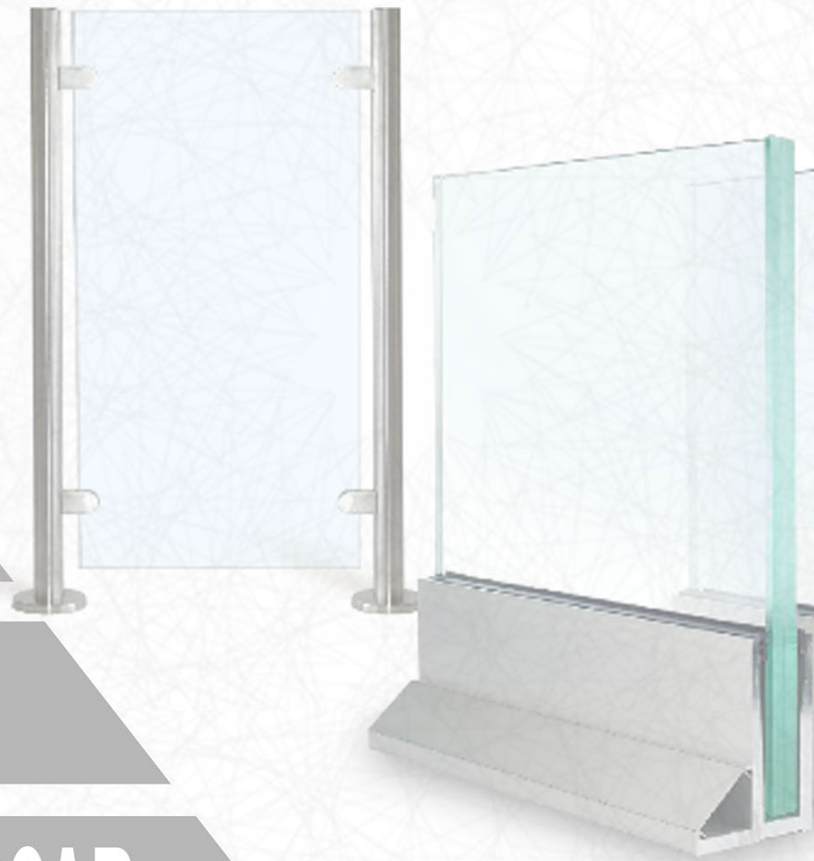

t a s a e
aceros
especiales s.l.

- 01** Tapones y terminaciones
P.04
- 02** Embellecedores
P.06
- 03** Bases y anclajes
P.09
- 04** Núcleos y varillas
P.12
- 05** Pinzas
P.15
- 06** Casquillos
P.18
- 07** Tensores
P.19
- 08** Conectores
P.21
- 09** Soportes
P.24
- 10** Pasamanos de pared
y tiradores de puerta
P.28

Calidad 316 Acabado brillante	316B
Calidad 304 Acabado brillante	304B
Calidad 316 Acabado satinado	316S
Calidad 304 Acabado satinado	304S
Calidad 316 No pulido	316N
Adhesivo retenedor	
Llave allen	
Llave hexagonal	
Martillo de nylon	
Destornillador de estrella	
Producto regulable	
Producto para soldar	
Diámetro tubo cilíndrico	
Medidas tubo cuadrado	
Medidas tubo rectangular	
Espesor del tubo	E
Grados de inclinación	G
Métrica del tornillo	M
Radio de la curva	R
Espesor del vidrio	V
Grosor del cable	W
Longitud mínima	LM

TAPONES Y TERMINACIONES

Stock permanente

Acabado o calidad disponible en stock, salvo rotura temporal. Entrega inmediata

Preguntar disponibilidad

Acabado o calidad disponible hasta final de existencias o bajo pedido.

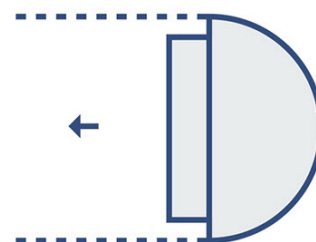

Tapón con radio

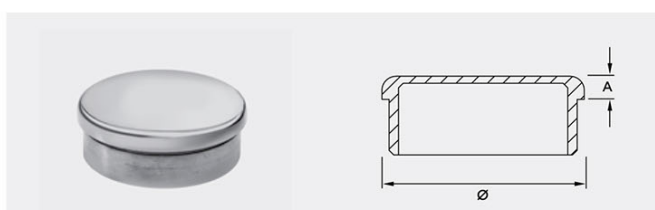

Stock permanente	316B	Preguntar disponibilidad		
		316S	304S	304B
Referencia	Ø	E	A	
TPF-25	25	1,5	4	
TPF-30	30	1,5	5	
TPF-33	33	1,5	5	
TPF-38	38	1,5	5	
TPF-40	40	1,5	5	
TPF-43	43	1,5	5	
TPF-50	50,8	1,5	6	
TPF-63	63,5	1,5	6	

Tapón macizo

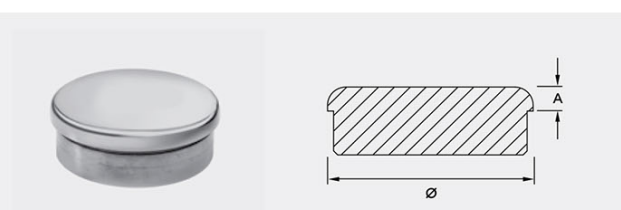

Stock permanente	316B	Preguntar disponibilidad		
		316S	304S	304B
Referencia	Ø	E	A	
TP-12	12	1	3	
TP-15	15	1,5	4	
TP-16/1	16	1	3,5	
TP-16	16	1,5	4	
TP-18	18	1,5	4	
TP-20	20	1,5	4	
TP-23	23	1,5	4	
TP-25	25	1,5	4	
TP-28	28	1,5	5	
TP-30	30	1,5	5	
TP-33	33	1,5	5	
TP-35	35	1,5	5	
TP-38	38	1,5	5	
TP-40	40	1,5	5	
TP-43	43	1,5	5	
TP-50	50,8	1,5	5	
TP-53	53	1,5	5	
TP-63	63,5	1,5	5	

Tapón plano

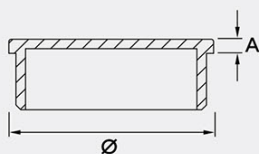

Stock permanente 316B Preguntar disponibilidad 316S 304S 304B

Referencia	Ø	E	A
TX-43	43	1,5	3
TX-50	50,8	1,5	3

Terminación codo ciego

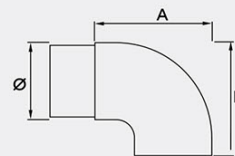

Stock permanente 316B Preguntar disponibilidad 316S

Referencia	Ø	E	A	B
TCC-43	43	1,5	62	62

Tapón esférico

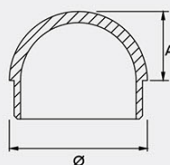

Stock permanente 316B Preguntar disponibilidad 316S 304S 304B

Referencia	Ø	E	A
TPE-43	43	1,5	22
TPE-50	50,8	1,5	26

Tapón semiesférico

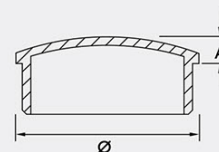

Stock permanente 316B Preguntar disponibilidad 316S 304S 304B

Referencia	Ø	E	A
TPS-43	43	1,5	6
TPS-50	50,8	1,5	8

Tapón roscado

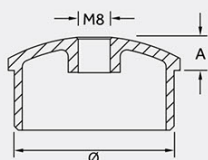

Stock permanente 316B Preguntar disponibilidad 316S

Referencia	Ø	E	A
TBF-43	43	1,5	22

Esféra roscada

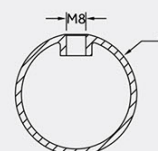

Stock permanente 316B Preguntar disponibilidad 316S

Referencia	A
BF-30	30
BF-50	50
BF-60	60

Tapón rectangular



Tapón Cuadrado



Stock permanente	316B	Preguntar disponibilidad	316S	304S	304B
Referencia	☒	E	A		
TC-40/20	40x20	1,5	5		

Stock permanente	316B	Preguntar disponibilidad	316S	304S	304B
Referencia	☒	E	A		
TC-20	20x20	1,5	5		
TC-30	30x30	1,5	5		
TC-40	40x40	1,5	5		
TC-50	50x50	1,5	5		

EMBELLECEDORES

Stock permanente

Acabado o calidad disponible en stock, salvo rotura temporal. Entrega inmediata

Preguntar disponibilidad

Acabado o calidad disponible hasta final de existencias o bajo pedido.

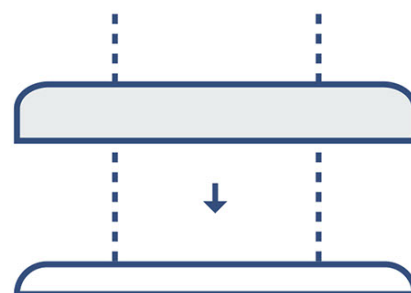

Embellecedor cilíndrico para tubo cuadrado

Stock permanente	316B	Preguntar disponibilidad	316S		
Referencia	☒	A	B		
TI-30X30	30x30	90	15		
TI-40X40	40x40	100	15		
TI-50X50	50x50	100	15		

Embellecedor tapa cuadrado

Stock permanente	316B	Preguntar disponibilidad	316S		
Referencia	☒	A	B		
Z-100/30	30x30	100	15		
Z-100/40	40x40	100	15		
Z-100/50	50x50	100	15		

**Embellecedor tapa
cilíndrico**

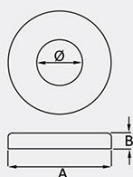

Stock permanente 316B Preguntar disponibilidad 316S

Referencia	Ø	A	B
TI-50/20	20	53	10
TI-50/23	23	53	10
TI-65/10	10	65	12
TI-65/12	12	65	12
TI-65/25	25	65	12
TI-65/28	28	65	12
TI-65/30	30	65	12
TI-65/33	33	65	12
TI-90/35	35	92	15
TI-90/38	38	92	15
TI-90/40	40	92	15
TI-100/43	43	100	15
TI-100/50	50,8	100	15
TI-100/53	53	100	15
TI-100/60,3	60,3	100	15
TI-100/63,5	63,5	100	15
TI-120/63,5	63,5	120	17

**Embellecedor
abombado**

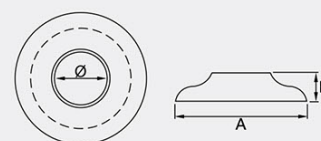

Stock permanente 316B Preguntar disponibilidad 316S

Referencia	Ø	A	B
F-65/20	20	65	15
F-65/25	25	65	15
F-65/30	30	65	15
F-90/10	10	90	20
F-90/30	30	90	20
F-90/33	33	90	20
F-90/38	38	90	20
F-100/43	43	100	22
F-100/50	50,8	100	22
F-100/53	53	100	22

**Embellecedor abombado
con tornillo**

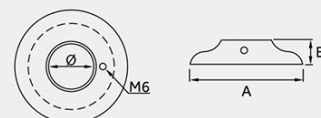

Stock permanente 316B Preguntar disponibilidad 316S

Referencia	Ø	A	B
FT-65/25	25	65	15
FT-65/30	30	65	15
FT-90/30	30	90	20
FT-90/33	33	90	20
FT-90/38	38	90	20
FT-100/43	43	100	22
FT-100/50	50,8	100	22

**Embellecedor
tapa rectangular**

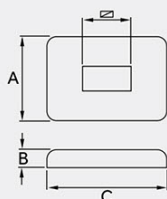

Stock permanente 316B Preguntar disponibilidad 316S

Referencia	☒	A	B	C
ZR-40/8	40x8	70	15	100
ZR-40/10	40x10	70	15	100
ZR-40/20	40x20	70	15	100
ZR-50/8	50x8	70	15	100
ZR-50/10	50x10	70	15	100

**Embellecedor
rectangular**

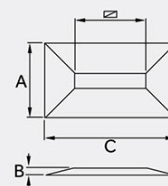

Stock permanente 316B Preguntar disponibilidad 316S

Referencia	☒	A	B	C
FR-30/10	30x10	53	4	82
FR-40/8	40x8	53	4	82
FR-40/10	40x10	53	4	93
FR-50/8	50x8	53	4	82
FR-50/10	50x10	53	4	93

**Embellecedor cilíndrico
para tubo rectangular**

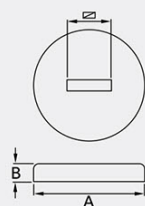

Stock permanente 316B Preguntar disponibilidad 316S

Referencia	☒	A	B
TI-40X8	40x8	90	15
TI-40X10	40x10	90	15
TI-50X8	50x8	90	15
TI-50X10	50x10	90	15

BASES Y ANCLAJES

Stock permanente

Acabado o calidad disponible en stock, salvo rotura temporal. Entrega inmediata

Preguntar disponibilidad

Acabado o calidad disponible hasta final de existencias o bajo pedido.

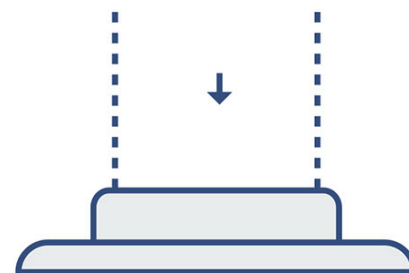

Base cilíndrica para pared



Stock permanente	316B	Preguntar disponibilidad	316S	
Referencia	Ø	A	B	
BFC-43	43	80	25	
BFC-50	50,8	102	32	

Base entallada para pared



Stock permanente	316B	Preguntar disponibilidad	316S	
Referencia	Ø	A	B	
BFE-43	43	86	25	
BFE-50	50,8	100	28	

Base cilíndrica con tapa para pared



Stock permanente	316B	Preguntar disponibilidad	316S	
Referencia	Ø	A	B	
BFT-43	43	82	28	

Base con codo para pared



Stock permanente	316B	Preguntar disponibilidad	316S		
Referencia	Ø	E	A	B	C
BC-43	43	1,5	80	70	48

Pletina cuadrada para soldar

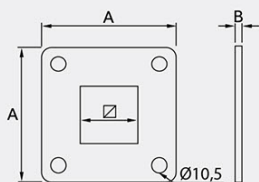
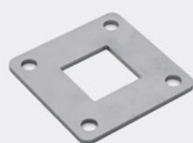

Stock permanente

316N

Referencia	▣	A	B
PSZ-30	30x30	95	4
PSZ-40	40x40	95	4
PSZ-50	50x50	95	4

Pletina cilíndrica para soldar

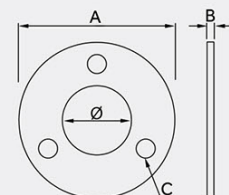

Stock permanente

316N

Referencia	Ø	A	B	C
PS-48/20	20	50	2	5,5
PS-63/25	25	60	3	6,5
PS-63/30	30	60	3	6,5
PS-63/33	33	60	3	6,5
PS-88/38	38	85	3	8,5
PS-88/40	40	85	3	8,5
PS-98/43	43	95	5	12
PS-98/50	50,8	95	5	12
PS-98/53	53	95	5	12
PS-98/63	63,5	95	5	12
PS-118/63	63,5	115	5	12

Pletina cilíndrica con mecha

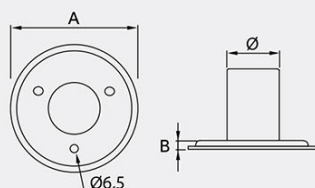

Stock permanente

316N

Referencia	Ø	E	A	B
PMI-95/40	43	1,5	95	5
PMI-95/47*	50,8	1,5	95	5

*Solo disponible en calidad 304 y no pulido

Pletina rectangular para soldar

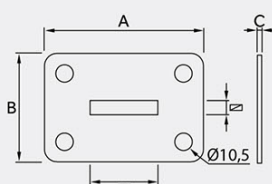

Stock permanente

316N

Referencia	▣	A	B	C
PSR-40/8	40x8	95	65	4
PSR-40/10	40x10	95	65	4
PSR-40/20	40x20	95	65	4
PSR-50/8	50x8	95	65	4
PSR-50/10	50x10	95	65	4

Base para tubo cuadrado para pared

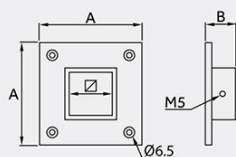

Stock permanente 316B Preguntar disponibilidad 316S

Referencia	▣	A	B
BFAQ-40	40x40	95	30

Anclaje regulable para tubo cilíndrico a lateral

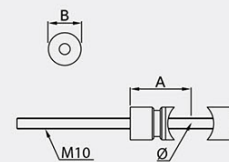

Stock permanente 316B Preguntar disponibilidad 316S

Referencia	Ø	A	B
SLRR-43	43	57-64	30

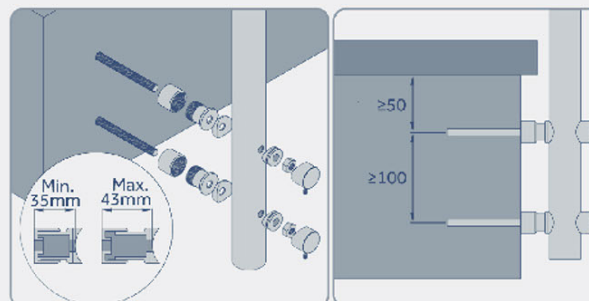

Base articulada para pared

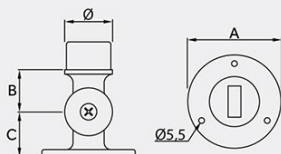

Stock permanente 316B Preguntar disponibilidad 316S

Referencia	Ø	E	A	B	C
BFA-43	43	1,5	83	37	40

Anclaje para tubo cuadrado o rectangular lateral

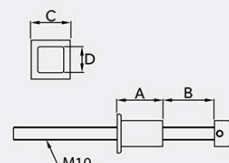

Stock permanente 316B Preguntar disponibilidad 316S

Referencia	A	B	C	D
SLS-20	35	40	30	20

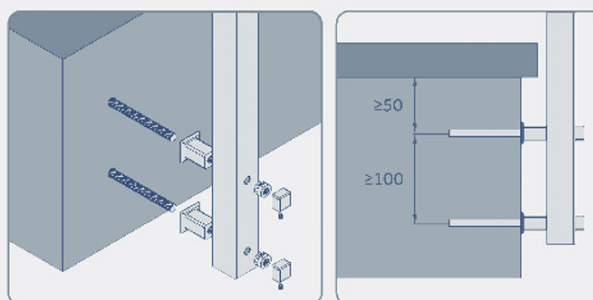

Anclaje para tubo cilíndrico lateral

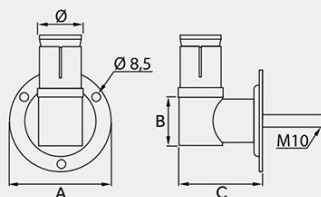

Stock permanente 316B Preguntar disponibilidad 316S 304S 304B

Referencia	Ø	E	A	B	C
SF-43	43	1,5	100	47	80

NÚCLEOS Y VARILLAS

Stock permanente

Acabado o calidad disponible en stock, salvo rotura temporal. Entrega inmediata

Preguntar disponibilidad

Acabado o calidad disponible hasta final de existencias o bajo pedido.

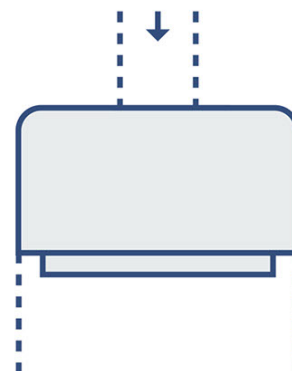

Núcleo para tubo cilíndrico



Stock permanente	316B	Preguntar disponibilidad	316S	304S	304B
Referencia		Ø	E	A	B
NF-43		43	1,5	15	12
NF-50		50,8	1,5	15	12

Núcleo para tubo cuadrado



Stock permanente	316B	Preguntar disponibilidad	316S	304S	304B
Referencia		Ø	E	A	B
NC-40		40x40	1,5	15	12
NC-50		50x50	1,5	15	12

Núcleo articulado para tubo cilíndrico



Stock permanente	316B	Preguntar disponibilidad	316S			
Referencia		Ø	E	A	B	R
NBR-43		43	1,5	23	25	21,5

Núcleo para tubo rectangular



Stock permanente	316B	Preguntar disponibilidad	316S		
Referencia		Ø	E	A	B
NR-40/20		40x20	1,5	15	12

Núcleo conector con radio



Stock permanente	316B	Preguntar disponibilidad	316S		
Referencia	Ø	E	A	B	R
CR-300/43	43	1,5	10	7	21,5
CR-300/50	50,8	1,5	15	7	25,4

Núcleo conector achaflanado

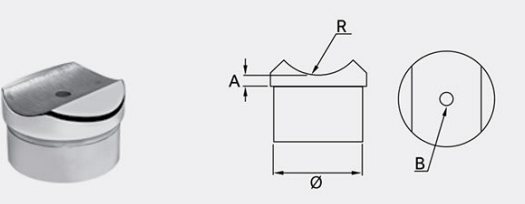
Stock permanente	316B	Preguntar disponibilidad	316S		
Referencia	Ø	E	A	B	R
CR-301/43	43	1,5	10	10	21,5
CR-301/50	50,8	1,5	15	7	25,4

Varilla recta con ménsula curva



Stock permanente	316B	Preguntar disponibilidad	316S	304S	304B
Referencia	A	B	C	R	
VM-R	100	12	45	21,5	

Varilla recta con ménsula plana



Stock permanente	316B	Preguntar disponibilidad	316S		
Referencia	A	B	C		
VM-P	100	12	45		

Varilla articulada con ménsula curva





Stock permanente	316B	Preguntar disponibilidad	316S	304S	304B
Referencia	A	B	C	R	
VR-R	100	12	45	21,5	

Varilla articulada con ménsula plana

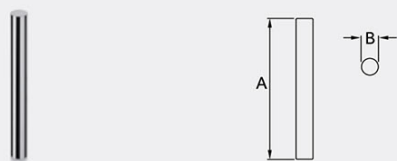

Stock permanente	316B	Preguntar disponibilidad	316S		
Referencia	A	B	C		
VR-P	100	12	45		

Varilla recta para soldar



Stock permanente 316B Preguntar disponibilidad 316S 304S 304B

Referencia	A	B
V-12	100	12

Varilla con escuadra articulada

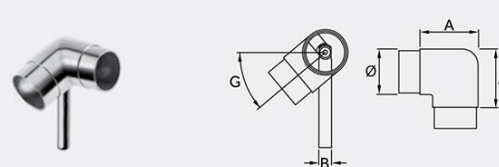

Stock permanente 316B Preguntar disponibilidad 316S

Referencia	Ø	E	A	B	G
VESD-43	43	1,5	56	12	29-40
VESI-43	43	1,5	56	12	29-40

Varilla con escuadra

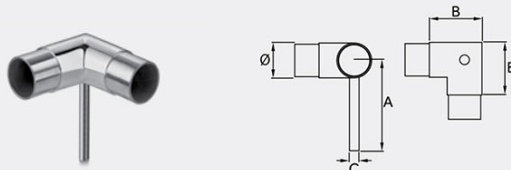

Stock permanente 316B Preguntar disponibilidad 316S 304S 304B

Referencia	Ø	E	A	B	C
VE-43	43	1,5	120	55	12

VESD-43

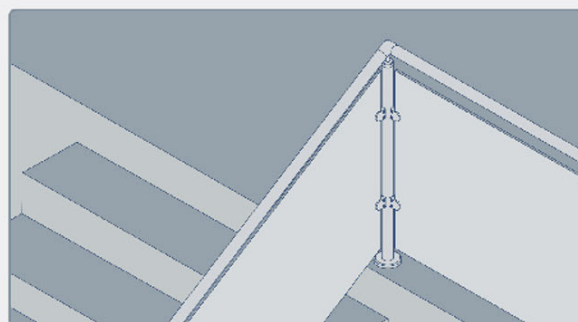

VESI-43

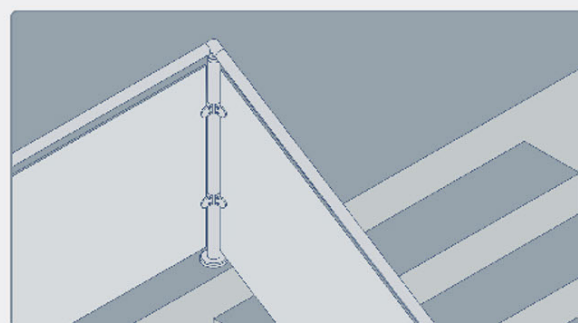

Conector interior tipo T

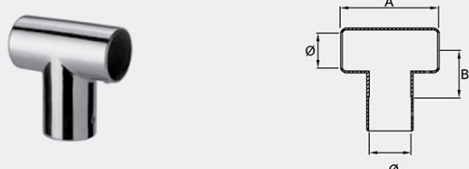

Stock permanente 304B Preguntar disponibilidad 304S

Referencia	Ø	A	B
TE-38	38	85	40
TE-43	43	85	42
TE-50	50,8	85	44

Varilla articulada con casquillo



Varilla recta con casquillo



Stock permanente	316B	Preguntar disponibilidad	316S		
Referencia		Ø	A	B	
VRC-43		43	100	12	

Stock permanente	316B	Preguntar disponibilidad	316S		
Referencia		Ø	A	B	
VC-43		43	100	12	

PINZAS

Stock permanente

Acabado o calidad disponible en stock, salvo rotura temporal. Entrega inmediata

Preguntar disponibilidad

Acabado o calidad disponible hasta final de existencias o bajo pedido.

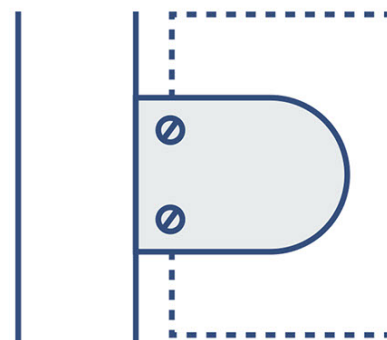

Pinza apoyo plano



Pinza apoyo curvo



Stock permanente	316B	Preguntar disponibilidad	316S	304S	304B
Referencia		A	B	C	V
PV-6/8		40	55	18	6/8
PV-8/10		40	55	18	8/10
PV-10/12		45	62	18	10/12

Stock permanente	316B	Preguntar disponibilidad	316S	304S	304B	
Referencia		A	B	C	V	R
PVR-6/8		40	55	18	6/8	21,5
PVR-8/10		40	55	18	8/10	21,5
PVR-10/12		45	62	18	10/12	21,5

**Pinza de seguridad
apoyo plano**



Stock permanente	316B	Preguntar disponibilidad		
		316S	304S	304B
Referencia	A	B	C	V
PVS-10	40	52	18	10

**Pinza de seguridad
apoyo curvo**



Stock permanente	316B	Preguntar disponibilidad			
		316S	304S	304B	
Referencia	A	B	C	V	R
PVRS-10	40	52	18	10	21,5

**Pinza cuadrada mediana
apoyo plano**



Stock permanente	316B	Preguntar disponibilidad		
		316S	304S	304B
Referencia	A	B	C	V
PVC - 6/8	46	46	18	6/8
PVC - 8/10	46	46	18	8/10

**Pinza cuadrada mediana
apoyo curvo**



Stock permanente	316B	Preguntar disponibilidad			
		316S	304S	304B	
Referencia	A	B	C	V	R
PVRC - 6/8	46	46	18	6/8	21,5
PVRC - 8/10	46	46	18	8/10	21,5

**Anclaje regulable
para vidrios**



Stock permanente	316B	Preguntar disponibilidad		
		316S		
Referencia	A	B	V	
BT-50	50	50	12/16,76	

**Pinza cuadrada grande
apoyo plano**



**Pinza cuadrada grande
apoyo curvo**



Stock permanente 316B Preguntar disponibilidad 316S

Referencia	A	B	C	V
PVL-12	70	56	23	12,76
PVL-13	70	56	23	13,52
PVL-16	70	56	23	16,76
PVL-17	70	56	23	17,52

Stock permanente 316B Preguntar disponibilidad 316S

Referencia	B	A	B	C	V
PVRL-12	70	56	23	12,76	25,4
PVRL-13	70	56	23	13,52	25,4
PVRL-16	70	56	23	16,76	25,4
PVRL-17	70	56	23	17,52	25,4

Información de producto

Ancho máximo del vidrio según referencia y espesor (mm)

Referencia	6,76*	8,76*	10,76*	12,76*	13,52*	16,76*	17,52*
PV / PVR	1000	1200	1200	1400	.	.	.
PVS / PVRS	.	.	1400
PVC / PVRC	1000	1200	1200
PVL / PVRL (1)	.	.	.	1600	1600	1600	1600

Altura máxima recomendada 800mm

(*) Vidrio laminado y templado (1) Con tope de seguridad

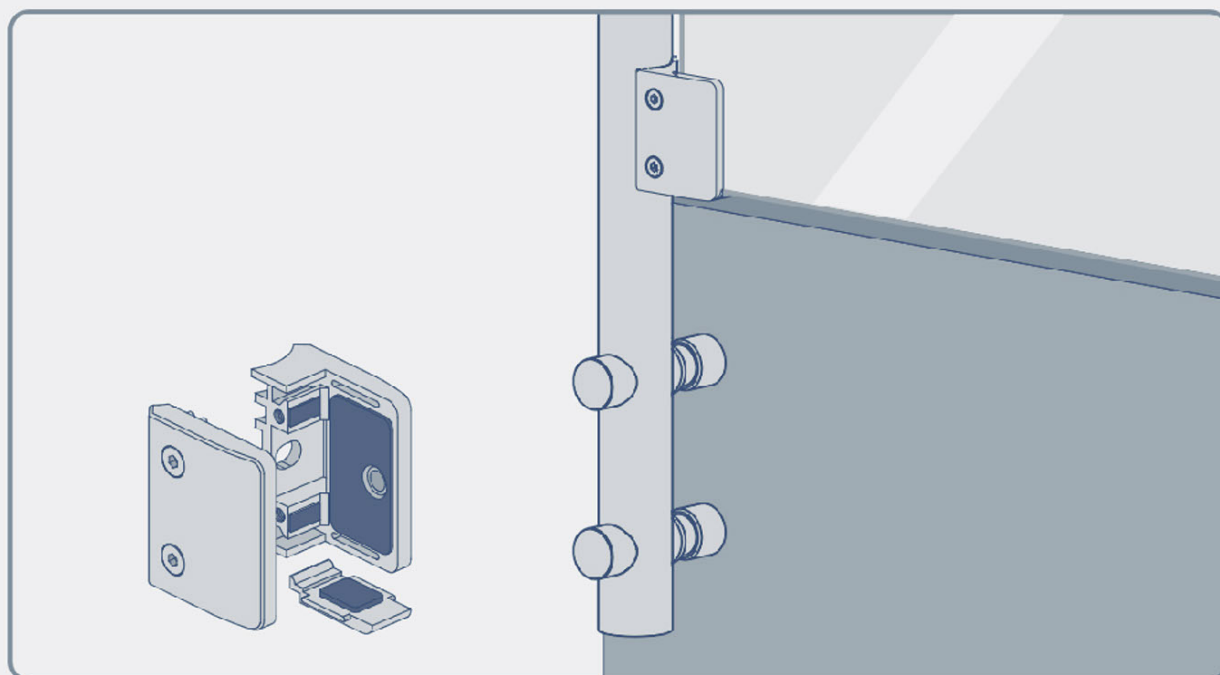

- Para montajes a lateral utilizar PVL o PVRL con tope de seguridad

CASQUILLOS

Stock permanente

Acabado o calidad disponible en stock, salvo rotura temporal. Entrega inmediata

Preguntar disponibilidad

Acabado o calidad disponible hasta final de existencias o bajo pedido.

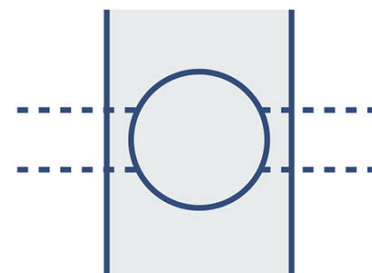

Casquillo articulado apoyo curvo



Stock permanente	316B	Preguntar disponibilidad	316S	304S	304B
Referencia	Ø	A	B	R	
F-22/12	12	20	22	21,5	
F-30/20	20	30	30	21,5	

Casquillo articulado apoyo plano



Stock permanente	316B	Preguntar disponibilidad	316S	304S	304B
Referencia	Ø	A	B		
FP-22/12	12	20	22		
FP-30/20	20	30	30		

Casquillo fijo para varilla apoyo curvo



Stock permanente	316B	Preguntar disponibilidad	316S	
Referencia	Ø	A	B	R
CRR-12	12	4	22	21,5

Casquillo fijo para varilla apoyo plano



Stock permanente	316B	Preguntar disponibilidad	316S
Referencia	Ø	A	B
CRP-12	12	4	22

Casquillo desmontable para varilla apoyo plano



Stock permanente	316B	Preguntar disponibilidad	316S	
Referencia	Ø	A	B	C
CF-12	12	20	15	18

Casquillo cilíndrico pasante



Stock permanente	316B	Preguntar disponibilidad	316S
Referencia	Ø	A	B
C-22/12	12	40	22

TENSORES

Stock permanente

Acabado o calidad disponible en stock, salvo rotura temporal. Entrega inmediata

Preguntar disponibilidad

Acabado o calidad disponible hasta final de existencias o bajo pedido.

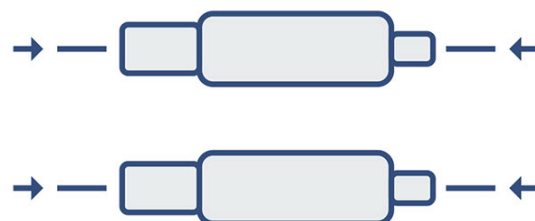

Tensor hexagonal



Stock permanente	316B	Preguntar disponibilidad	316S
Referencia	A	B	C
TN-4/5	25	55	4-5

Tensor cilíndrico



Stock permanente	316B	Preguntar disponibilidad	316S
Referencia	A	B	C
TBN-4/5	35	72	4-5

**Casquillo para
chapa**



Stock permanente 316B Preguntar disponibilidad 316S

Referencia	A	B	C	R
CC-30	15	32	0,8-2,5	21,5

**Tensor rápido
con horquilla**



Stock permanente 316B Preguntar disponibilidad 316S

Referencia	A	B	C
TNR-4	10	90	4
TNR-5	10	95	5

**Cable de acero
inoxidable**

Stock permanente 316N

Referencia	Ø	LM
CBL-4	4	25m
CBL-5	5	25m

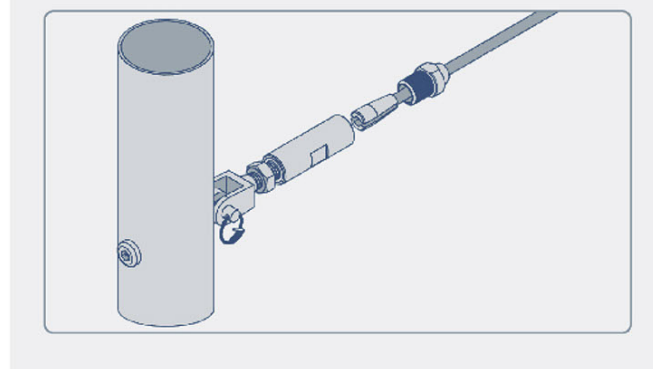

CONECTORES

Stock permanente

Acabado o calidad disponible en stock, salvo rotura temporal. Entrega inmediata

Preguntar disponibilidad

Acabado o calidad disponible hasta final de existencias o bajo pedido.

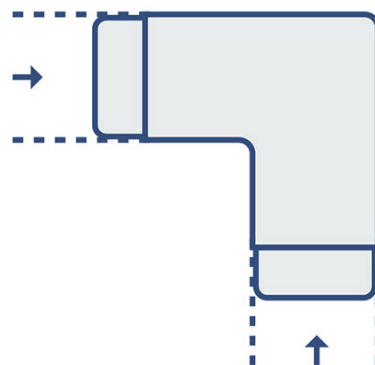

Escuadra



Stock permanente	316B	Preguntar disponibilidad	316S	304S	304B
Referencia	Ø	E	A	B	
E-20/43	43	1,5	70	70	
E-20/50	50,8	1,5	80	80	

Codo





Stock permanente	316B	Preguntar disponibilidad	316S	304S	304B
Referencia	Ø	E	A	B	
E-21/43	43	1,5	65	65	
E-21/50	50,8	1,5	70	70	

T de tres salidas



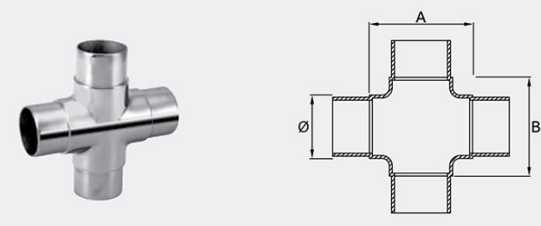

Stock permanente	316B	Preguntar disponibilidad	316S		
Referencia	Ø	E	A	B	
E-22/43	43	1,5	63	51	
E-22/50	50,8	1,5	67	54	

Cruz de cuatro salidas

Stock permanente	316B	Preguntar disponibilidad	316S		
Referencia	Ø	E	A	B	
E-23/43	43	1,5	70	70	
E-23/50	50,8	1,5	63	63	

Escuadra de cuatro salidas

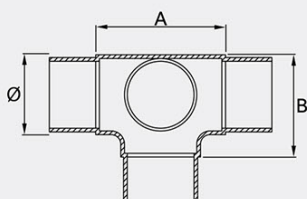

Stock permanente

316B

Preguntar disponibilidad

316S

Referencia	Ø	E	A	B
E-24/43	43	1,5	69	55
E-24/50	50,8	1,5	64	58

Escuadra de tres salidas

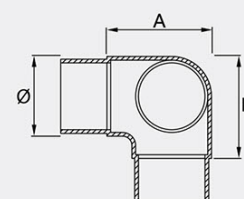

Stock permanente

316B

Preguntar disponibilidad

316S

Referencia	Ø	E	A	B
E-25/43	43	1,5	58	58
E-25/50	50,8	1,5	59	59

Codo a 135°

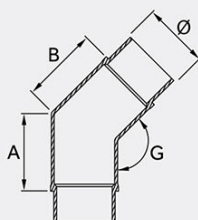

Stock permanente

316B

Preguntar disponibilidad

316S

Referencia	Ø	E	A	B	G
E-26/43	43	1,5	50	50	135

Codo giratorio

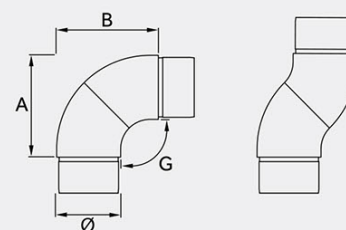

Stock permanente

316B

Preguntar disponibilidad

316S

Referencia	Ø	E	A	B	G
E-27/43	43	1,5	55	55	90-180

Casquillo de empalme

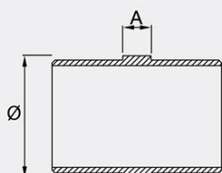

Stock permanente

316B

Preguntar disponibilidad

316S

Referencia	Ø	E	A
CE-12	12	1	10
CE-20	20	1,5	10
CE-38	38	1,5	4
CE-43	43	1,5	4
CE-50	50,8	1,5	5

Rótula para tubo de 20mm

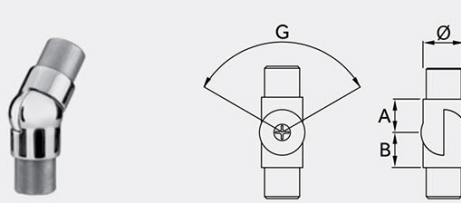
Stock permanente	316B	Preguntar disponibilidad	316S	304S	304B
Referencia	Ø	E	A	B	G
R-20	20	1,5	17	17	100-135

Rótula para tubo de 12mm



Stock permanente	316B	Preguntar disponibilidad	316S		
Referencia	Ø	E	A	B	G
R-12	12	1	12	10	0-180

Rótula para tubo de 43mm





Stock permanente	316B	Preguntar disponibilidad	316S	304S	304B
Referencia	Ø	E	A	B	G
R-43	43	1,5	25	25	100-135

Casquillo de empalme



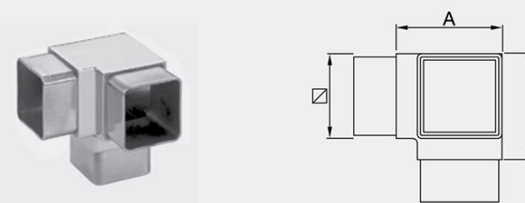

Stock permanente	316B	Preguntar disponibilidad	316S
Referencia	□	E	A
CEQ-40	40x40	1,5	4

Escuadra de tres salidas

Stock permanente	304B	Preguntar disponibilidad	304S	
Referencia	□	E	A	B
A2-40	40x40	1,5	50	50

Conector tipo T de tres salidas

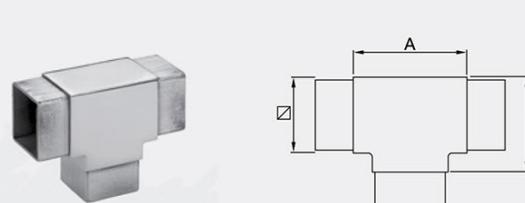
Stock permanente	304B	Preguntar disponibilidad	304S	
Referencia	□	E	A	B
A3-40	40x40	1,5	60	60

Conector tipo T de cuatro salidas

Stock permanente	304B	Preguntar disponibilidad	304S
Referencia	∅	E	A B
A4-40	40x40	1,5	60 50

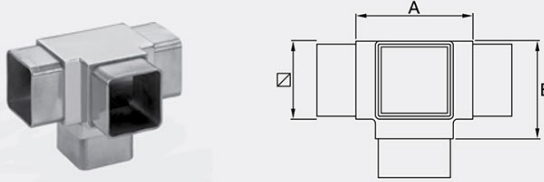
Conector tipo cruz de cuatro salidas

Stock permanente	304B	Preguntar disponibilidad	304S
Referencia	∅	E	A B
A5-40	40x40	1,5	60 60

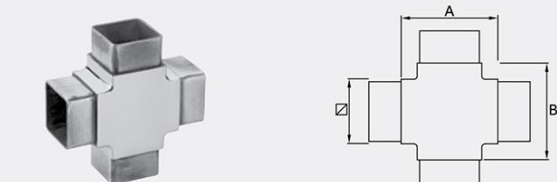
Escuadra

Stock permanente	316B	Preguntar disponibilidad	316S	304S	304B
Referencia	∅	E	A	B	
A-40	40x40	1,5	50	50	
A-40/20	40x20	1,5	50	50	

SOPORTES

Stock permanente

Acabado o calidad disponible en stock, salvo rotura temporal. Entrega inmediata

Preguntar disponibilidad

Acabado o calidad disponible hasta final de existencias o bajo pedido.

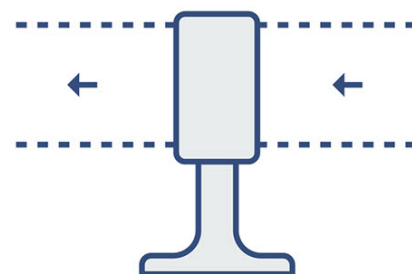

Soporte esférico pasante



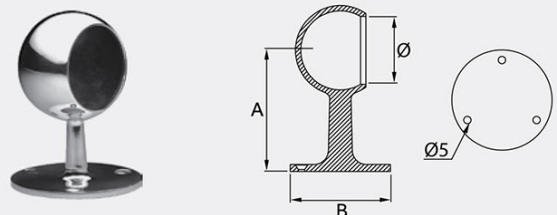

Stock permanente	316B	Preguntar disponibilidad	316S
Referencia	∅	A	B
SP-34/43	43	72	68
SP-34/50	50,8	75	69

Soporte esférico ciego

Stock permanente	316B	Preguntar disponibilidad	316S
Referencia	∅	A	B
SP-35/43	43	72	68
SP-35/50	50,8	75	69

Soporte cilíndrico pasante

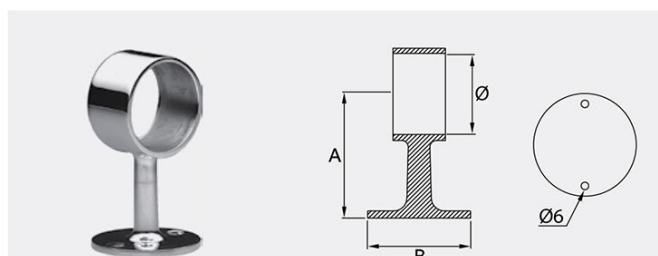

Stock permanente

316B

Preguntar disponibilidad

316S

Referencia	Ø	A	B
SP-36/43	43	72	68
SP-36/50	50,8	85	69

Soporte cilíndrico ciego

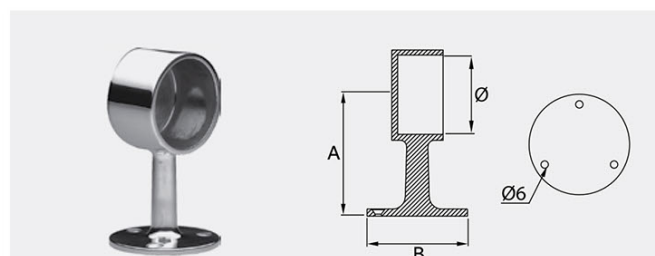

Stock permanente

316B

Preguntar disponibilidad

316S

Referencia	Ø	A	B
SP-37/43	43	72	68
SP-37/50	50,8	85	63

Soporte mecanizado

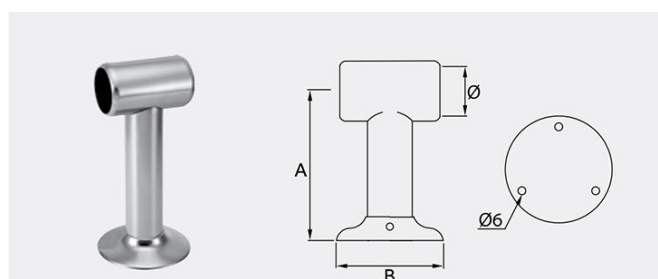

Stock permanente

304B

Preguntar disponibilidad

304S

Referencia	Ø	A	B
SP-120/38	38	125	90
SP-120/43	43	130	90
SP-120/50	50,8	130	90
SP-165/38	38	165	90
SP-165/43	43	180	90
SP-165/50	50,8	185	90

Soporte de fundición

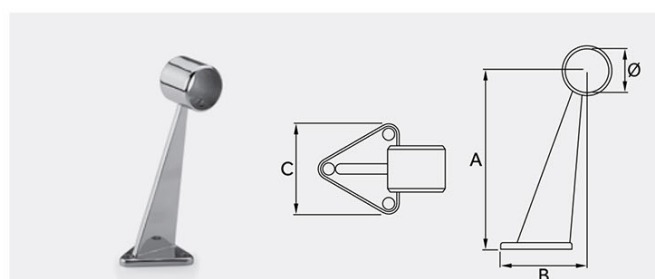

Stock permanente

316B

Preguntar disponibilidad

316S

Referencia	Ø	A	B	C
SPN-200	43	180	80	78
SPN-250	50,8	225	90	78

Soporte con tapa



Stock permanente	316B	Preguntar disponibilidad	316S	304S	304B
Referencia		A	B	C	
SBT-10		70	55	65	

Soporte con tapa y ménsula



Stock permanente	316B	Preguntar disponibilidad	316S	304S	304B
Referencia		A	B	C	R
SBT-38/43		70	58	65	21,5

Soporte para pasamanos



Stock permanente	304B	Preguntar disponibilidad	304S	
Referencia		A	B	C
SBP-10		83	53	65

Soporte para pasamanos con ménsula



Stock permanente	304B	Preguntar disponibilidad	304S		
Referencia		A	B	C	R
SBM-38/43		83	53	65	21,5

Soporte con taco metálico



Stock permanente	304B	Preguntar disponibilidad	304S	
Referencia		A	B	C
ST-10		60	53	65

Soporte con taco metálico y ménsula



Stock permanente	304B	Preguntar disponibilidad	304S		
Referencia		A	B	C	R
STM-38/43		60	53	65	21,5

Soporte a vidrio con varilla articulada



Stock permanente 316B Preguntar disponibilidad 316S

Referencia	A	B	C	V	R
SVTR	50	80	100	6-17,52	21,5

Soporte a tubo con varilla articulada



Stock permanente 316B Preguntar disponibilidad 316S

Referencia	A	B	R
SBR-43	80	100	21,5

Soporte a vidrio con varilla recta



Stock permanente 316B Preguntar disponibilidad 316S

Referencia	A	B	C	V	R
SVT	50	80	100	6/17,52	21,5

SVT

Soporte a tubo con varilla recta



Stock permanente 316B Preguntar disponibilidad 316S

Referencia	A	B	R
SB-43	80	100	21,5

SBR-43 **SB-43**

PASAMANOS DE PARED Y TIRADORES DE PUERTA

Stock permanente

Acabado o calidad disponible en stock, salvo rotura temporal. Entrega inmediata

Preguntar disponibilidad

Acabado o calidad disponible hasta final de existencias o bajo pedido.



Pasamano de pared

Stock permanente	316B	Preguntar disponibilidad	316S	304S	304B
Referencia	Ø	A	B	C	S
PDS-1000	30-38-43	≥1000*	≥30*	≥30*	2
PDS-2000	30-38-43	≥2000*	≥30*	≥30*	3
PDS-3000	30-38-43	≥3000*	≥30*	≥30*	4
PDS-4000	30-38-43	≥4000*	≥30*	≥30*	5

* Medida personalizable por el cliente

Tirador recto a medida

Stock permanente	316B	Preguntar disponibilidad	316S	304S	304B
Referencia	Ø	A	B	C	D
TR-1000	30-38-43	≤1000*	45	≥10*	*
TR-1500	30-38-43	≤1500*	45	≥10*	*
TR-2000	30-38-43	≤2000*	45	≥10*	*
TR-2500	30-38-43	≤2500*	45	≥10*	*

* Medida personalizable por el cliente

Tirador recto estandar

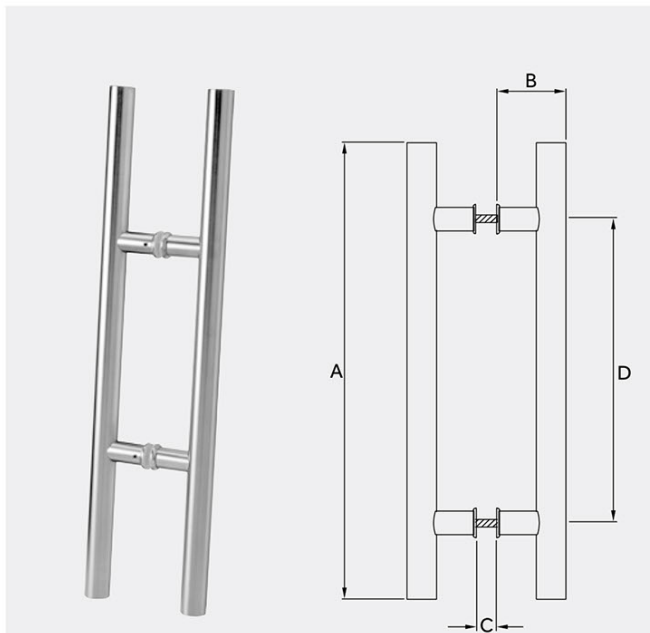

Stock permanente 304B Preguntar disponibilidad 304S

Referencia	Ø	A	B	C	D
TR-610/32	25	610	80	10	250

Tirador curvo estandar

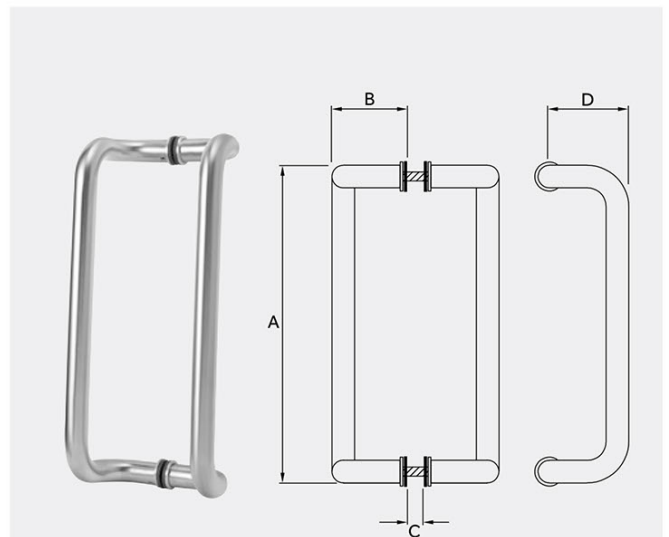

Stock permanente 304B Preguntar disponibilidad 304S

Referencia	Ø	A	B	C	D
TC-350	25	350	75	10	90
TC-600	25	600	75	10	90

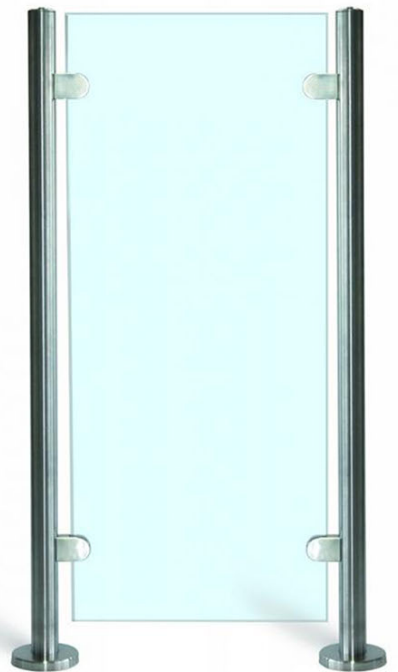
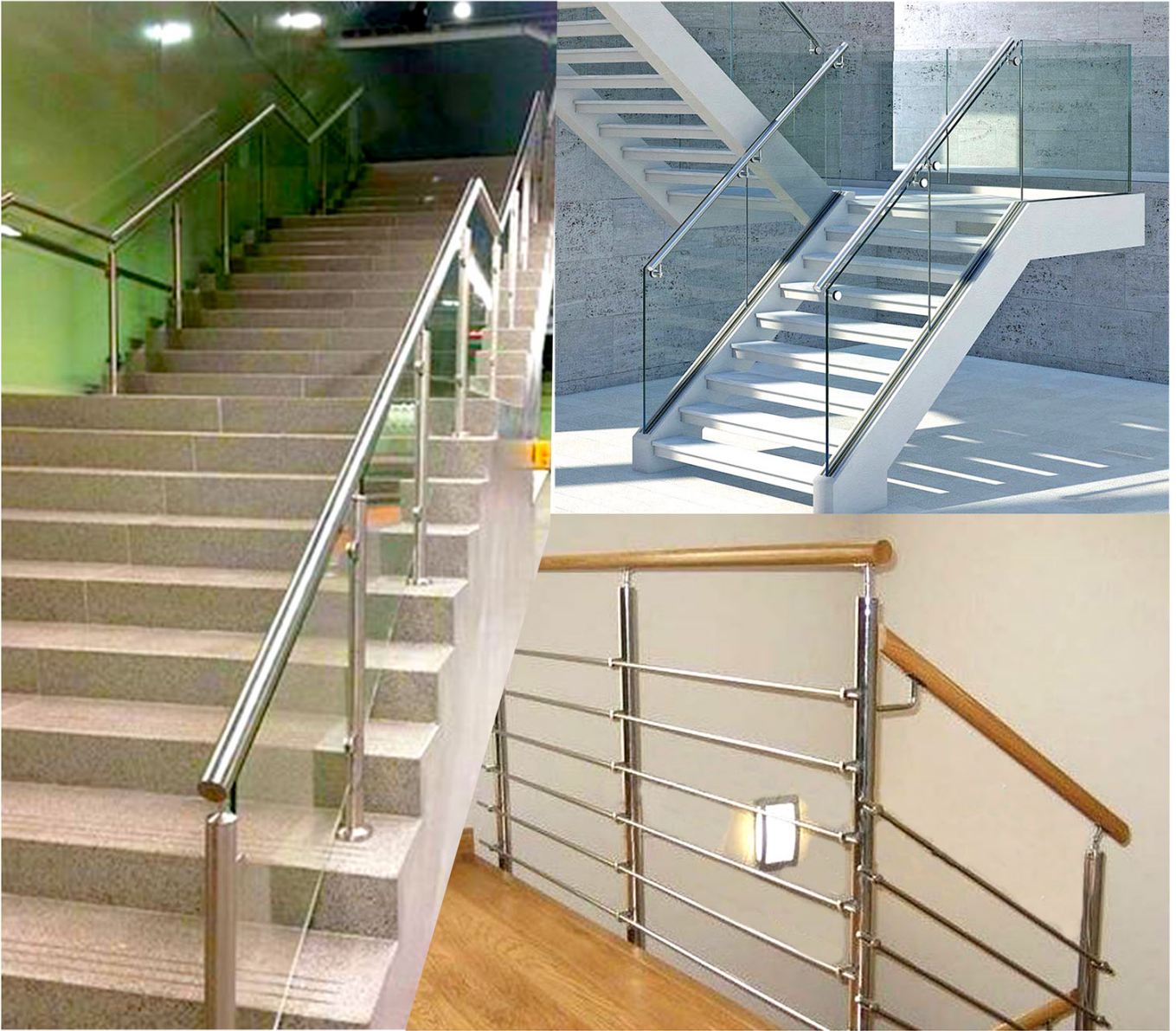



PERFILES DE ALUMINIO

SOPORTE BARANDILLA Y TAPA.

TAPA	REF: 4828
Peso (kg/m)	0.709
Perímetro (m)	0.352 m

SOPORTE	REF: 4827
Peso (kg/m)	4.992
Perímetro (m)	0.546 m

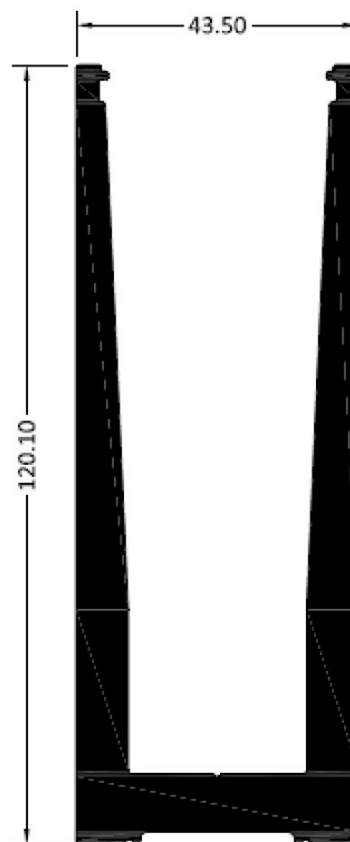
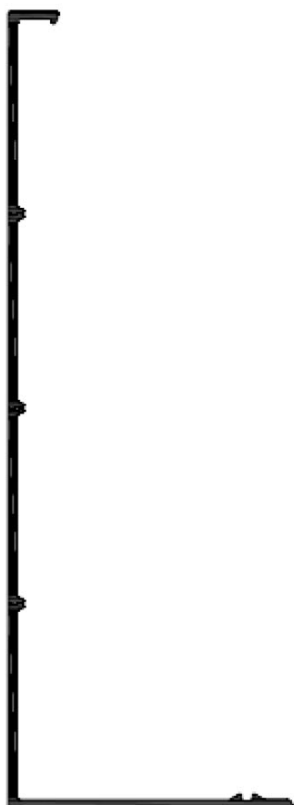

PERFILES DE ALUMINIO

SECCIONES CRISTAL 6+6.

SOBRE FORJADO.

EN CANTO DE FORJADO.

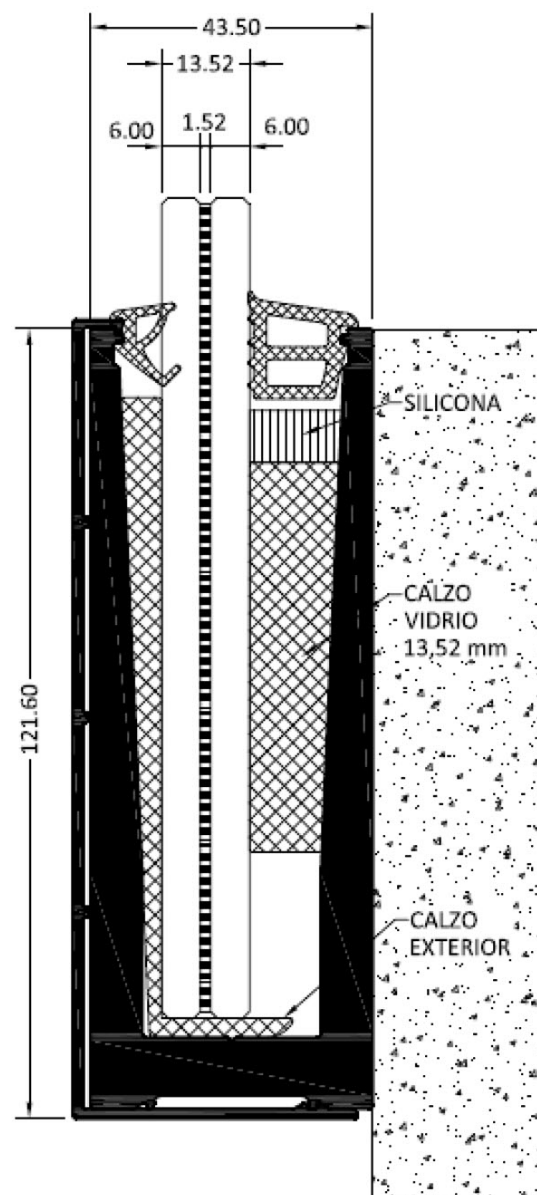
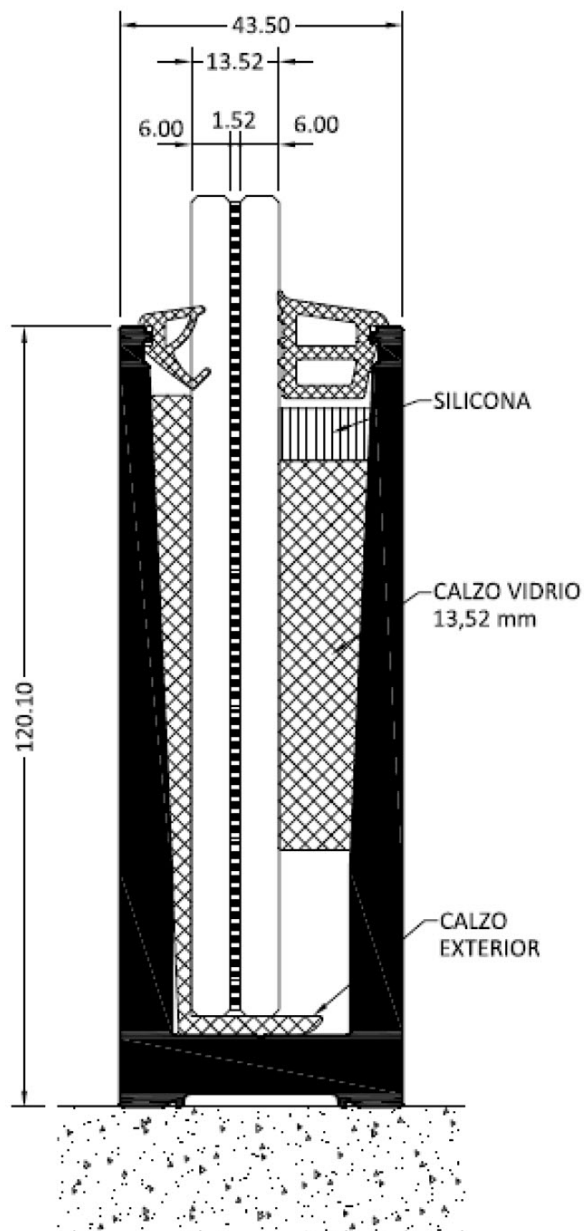

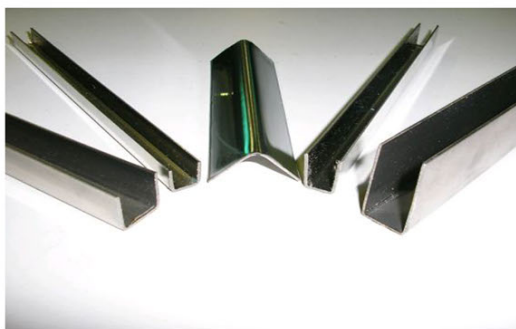

GAMA DE PERFILES 2018 U y L

Calidad	Articulo	Acabado	Dimensiones mm.	Espesor mm.	Longitud mm.
A-304	U	BAP	10 x 10 x 10	1	6.000
A-304	U	BAP	15 x 10 x 15	1	6.000
A-304	U	BAP	15 x 12 x 15	1	6.000
A-304	U	BAP	15 x 15 x 15	1	6.000
A-304	U	BAP	15 x 15 x 15	1,5	6.000
A-304	U	BAP	20 x 15 x 20	1	6.000
A-304	U	BAP	25 x 15 x 25	1	6.000
A-304	U	BAP	30 x 15 x 30	1	6.000
A-304	U	BAP	30 x 15 x 30	1,5	6.000
A-304	U	BAP	10 x 20 x 10	1	6.000
A-304	U	BAP	20 x 20 x 20	1	6.000
A-304	U	BAP	20 x 20 x 20	1,5	6.000
A-304	U	BAP	40 x 20 x 40	1,5	6.000
A-304	U	BAP	30 x 20 x 30	1,5	6.000
A-304	U	BAP	20 x 40 x 20	1,5	6.000
A-304	U	BAP	25 x 25 x 25	1,5	6.000
A-304	U	BAP	30 x 30 x 30	1,5	6.000
A-316L	U	BAP	15 x 12 x 15	1	6.000
A-316L	U	BAP	15 x 15 x 15	1	6.000
A-316L	U	BAP	20 x 15 x 20	1	6.000
A-316L	U	BAP	20 x 20 x 20	1	6.000
A-316L	U	BAP	30 x 15 x 30	1	6.000
A-316L	U	BAP	15 x 15 x 15	1,5	6.000
A-316L	U	BAP	30 x 15 x 30	1,5	6.000
A-304	U	SP	15 x 12 x 15	1	6.000
A-304	U	SP	15 x 15 x 15	1	6.000
A-304	U	SP	20 x 15 x 20	1	6.000
A-304	U	SP	30 x 15 x 30	1	6.000

A-304	L	BAP	10 x 10	1	6.000
A-304	L	BAP	15 x 15	1	6.000
A-304	L	BAP	20 x 20	1	6.000
A-304	L	BAP	20 x 20	1,5	6.000
A-304	L	BAP	25 x 25	1,5	6.000
A-304	L	BAP	30 x 30	1,5	6.000
A-304	L	BAP	40 x 40	1,5	6.000
A-304	L	BAP	50 x 50	1,5	6.000
A-304	L	texturado	20 x 20	0,8	6.000
A-316	L	BAP	20 x 20	1	6.000

A-304	L	BAP	20 x 10	1	6.000
A-304	L	BAP	30 x 15	1	6.000
A-304	L	BAP	40 x 20	1,5	6.000

BAP BRILLO ORIGEN CON PVC DE PROTECCION DE 70 MICRAS
SP SATINADO CON PVC DE PROTECCION DE 70 MICRAS

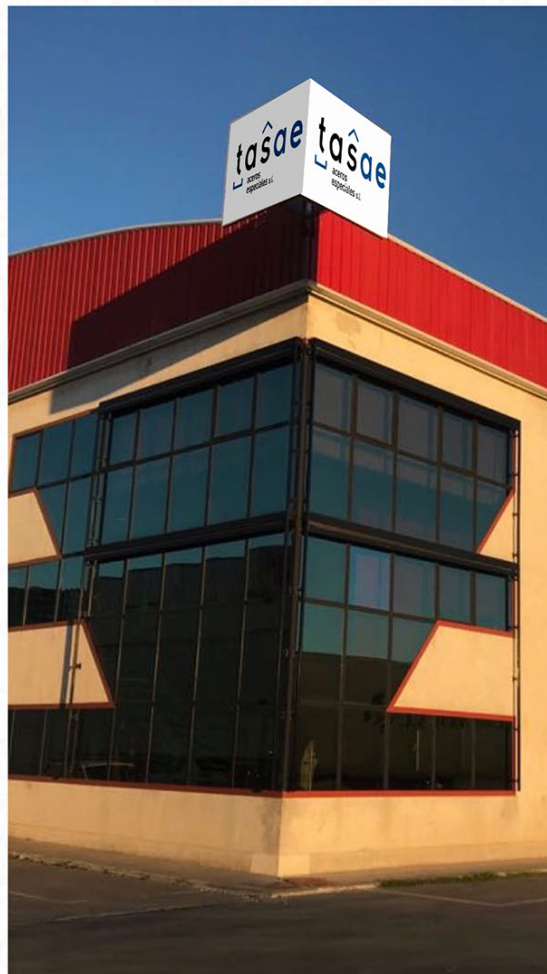

Pol. Ind. Las Quemadas
c/José de Gálvez y Aranda, 31-32 14014 CÓRDOBA
Tel : +34 957 41 84 78
info@tasae.es
www.tasae.es